

CONE

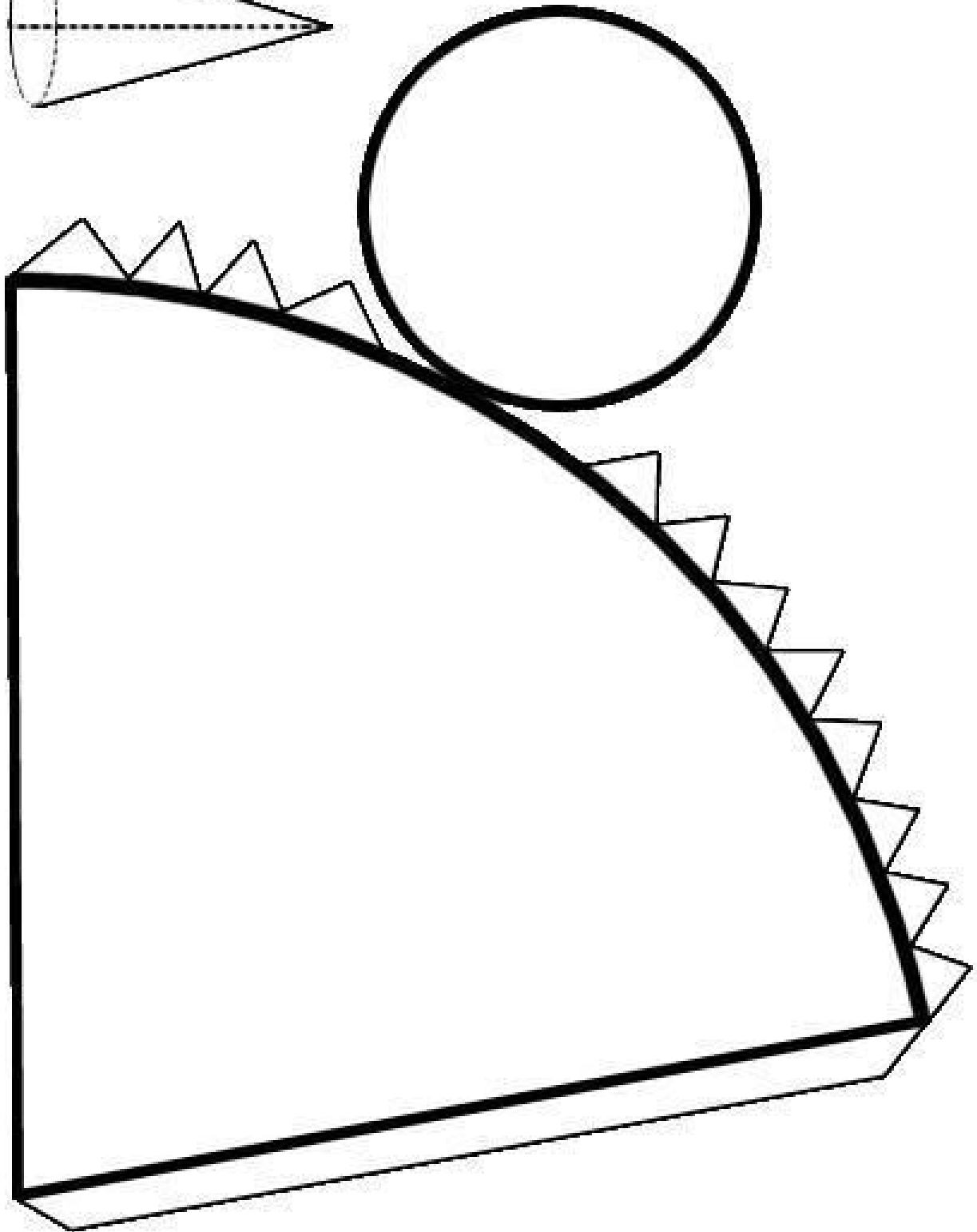

CILINDRO

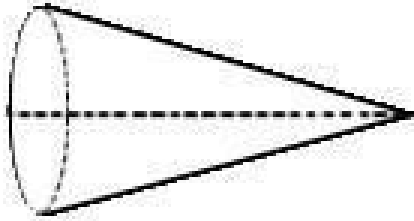
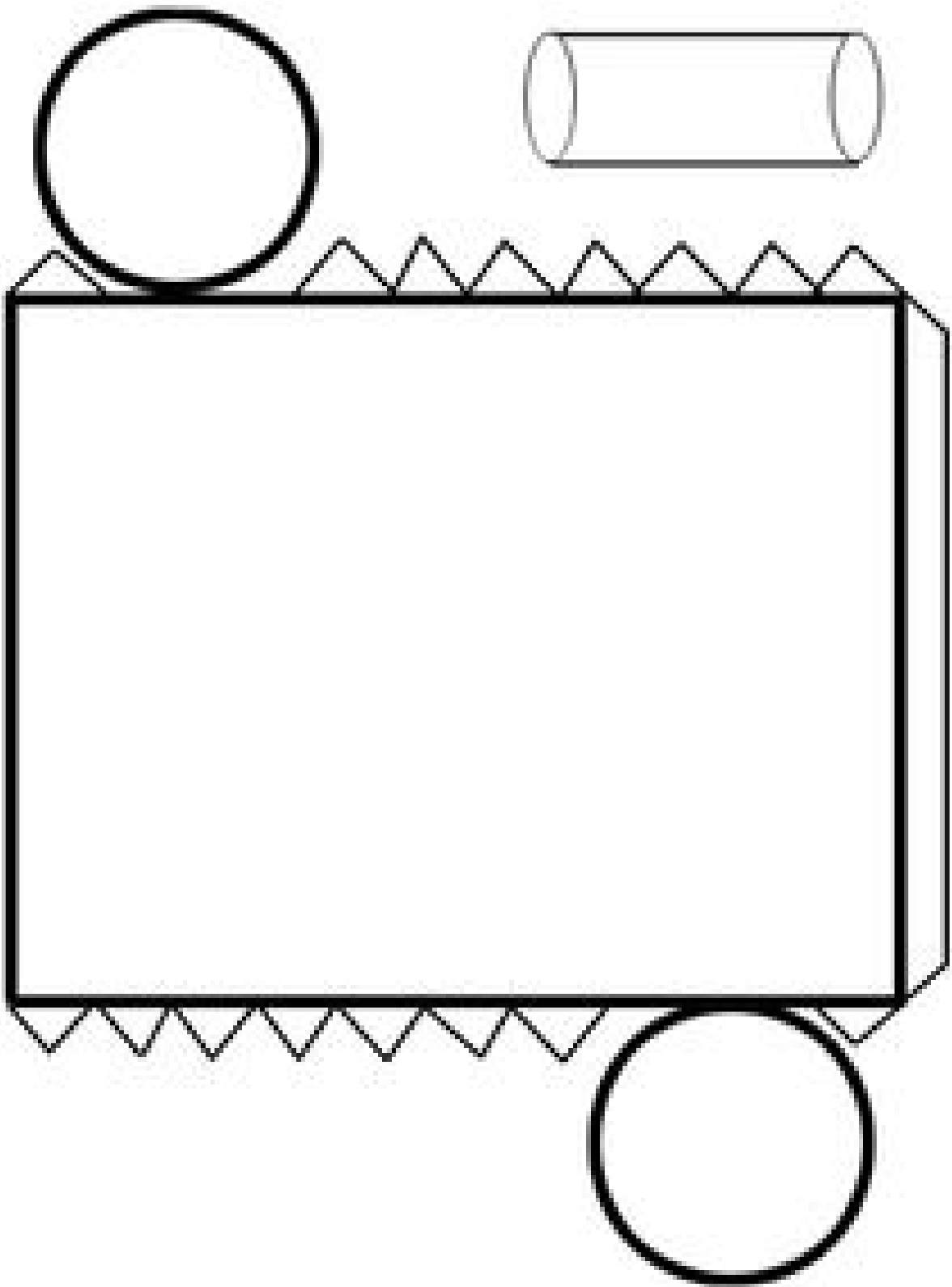

PIRÂMIDE TRIANGULAR

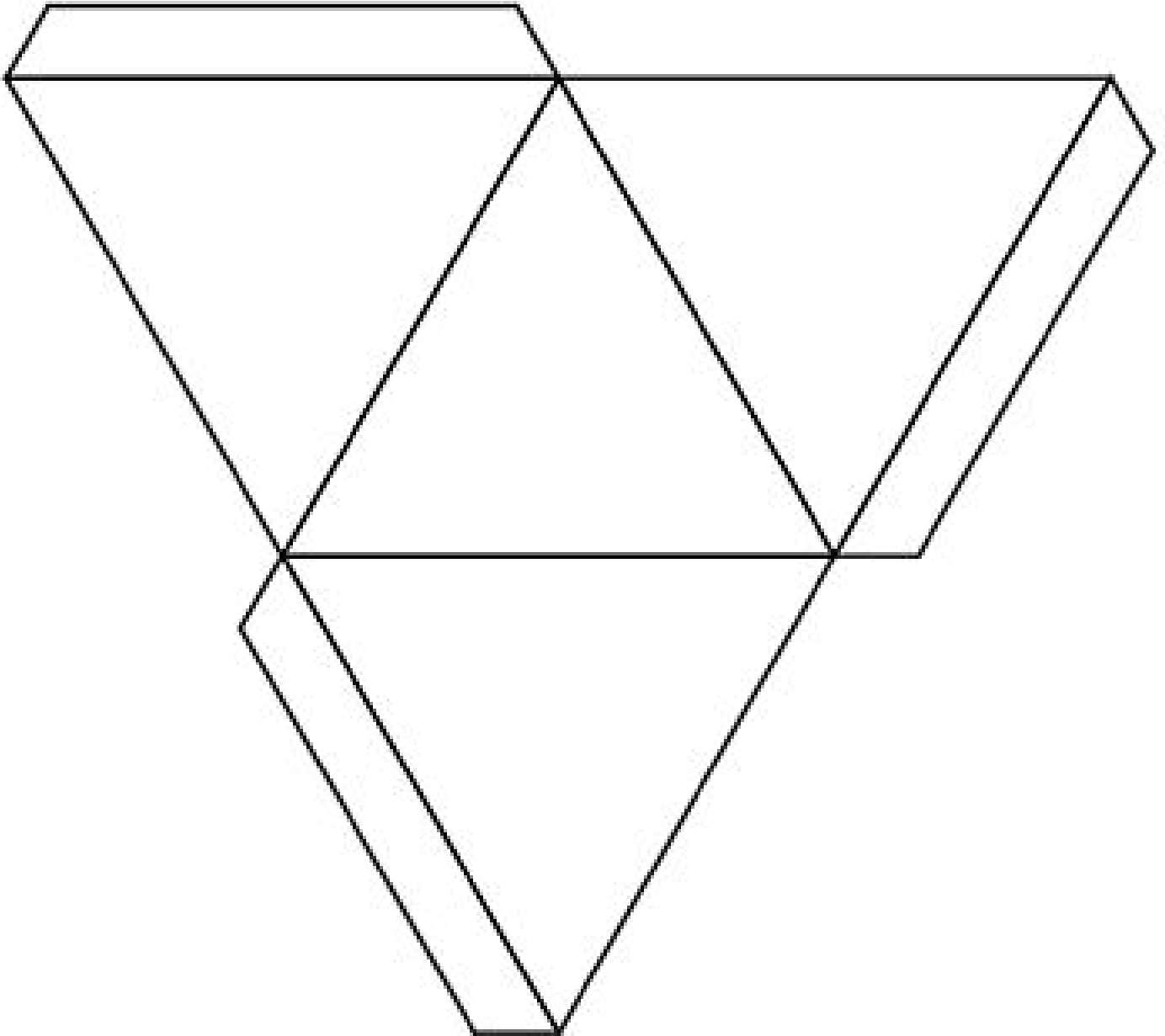

PRISMA TRIANGULAR

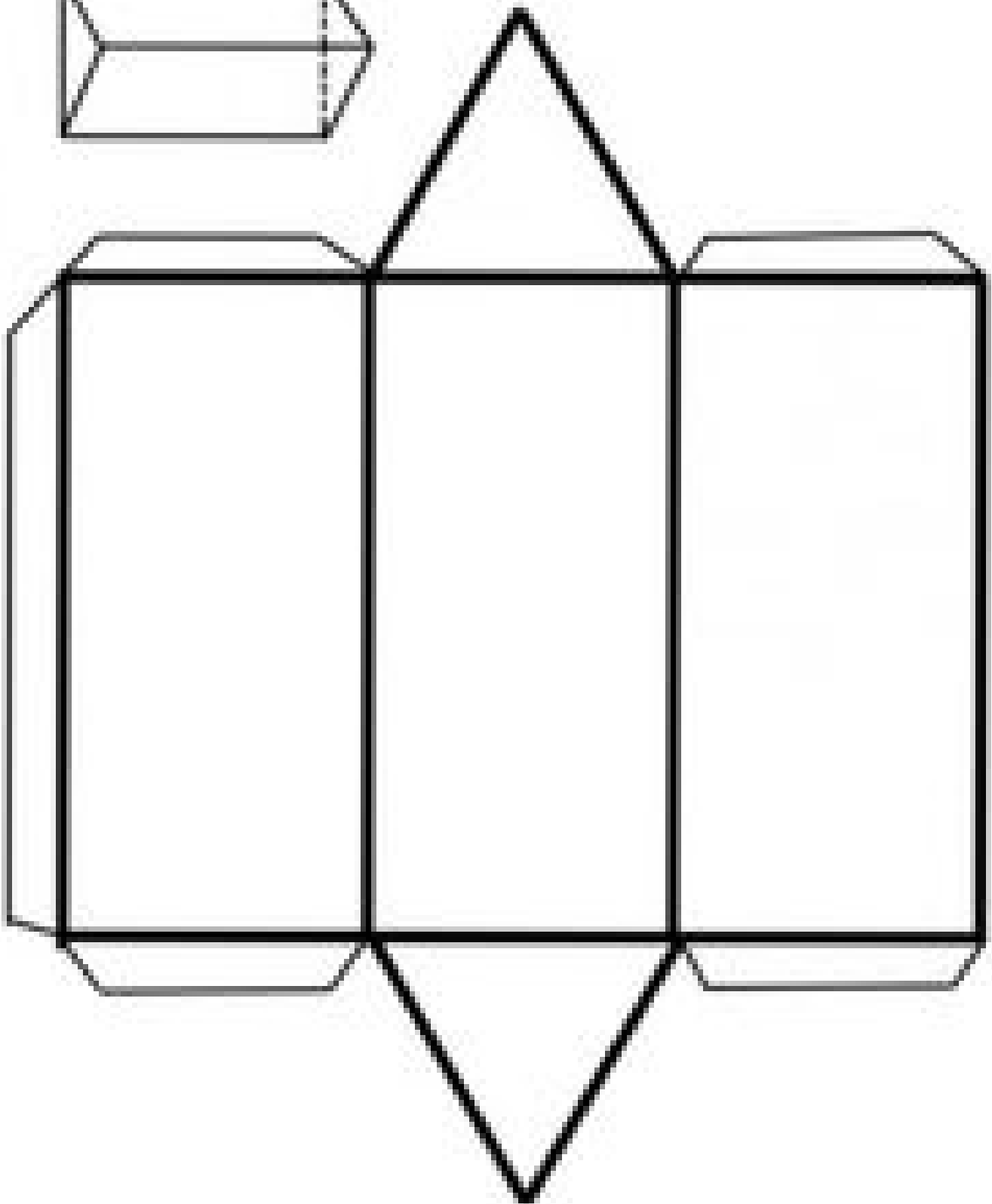
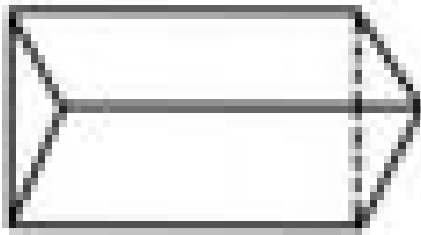

PIRÂMIDE QUADRANGULAR

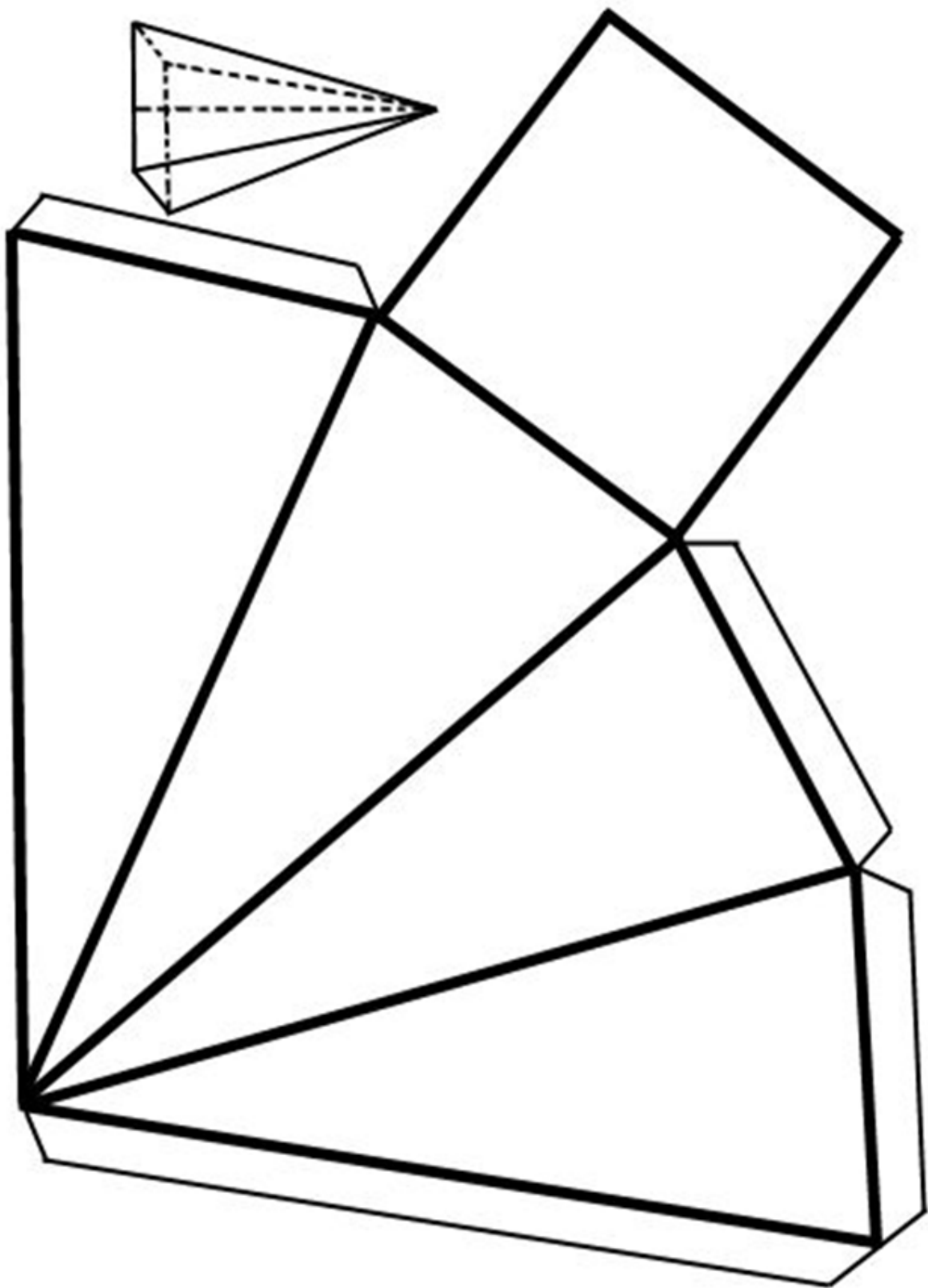

PRISMA QUADRANGULAR

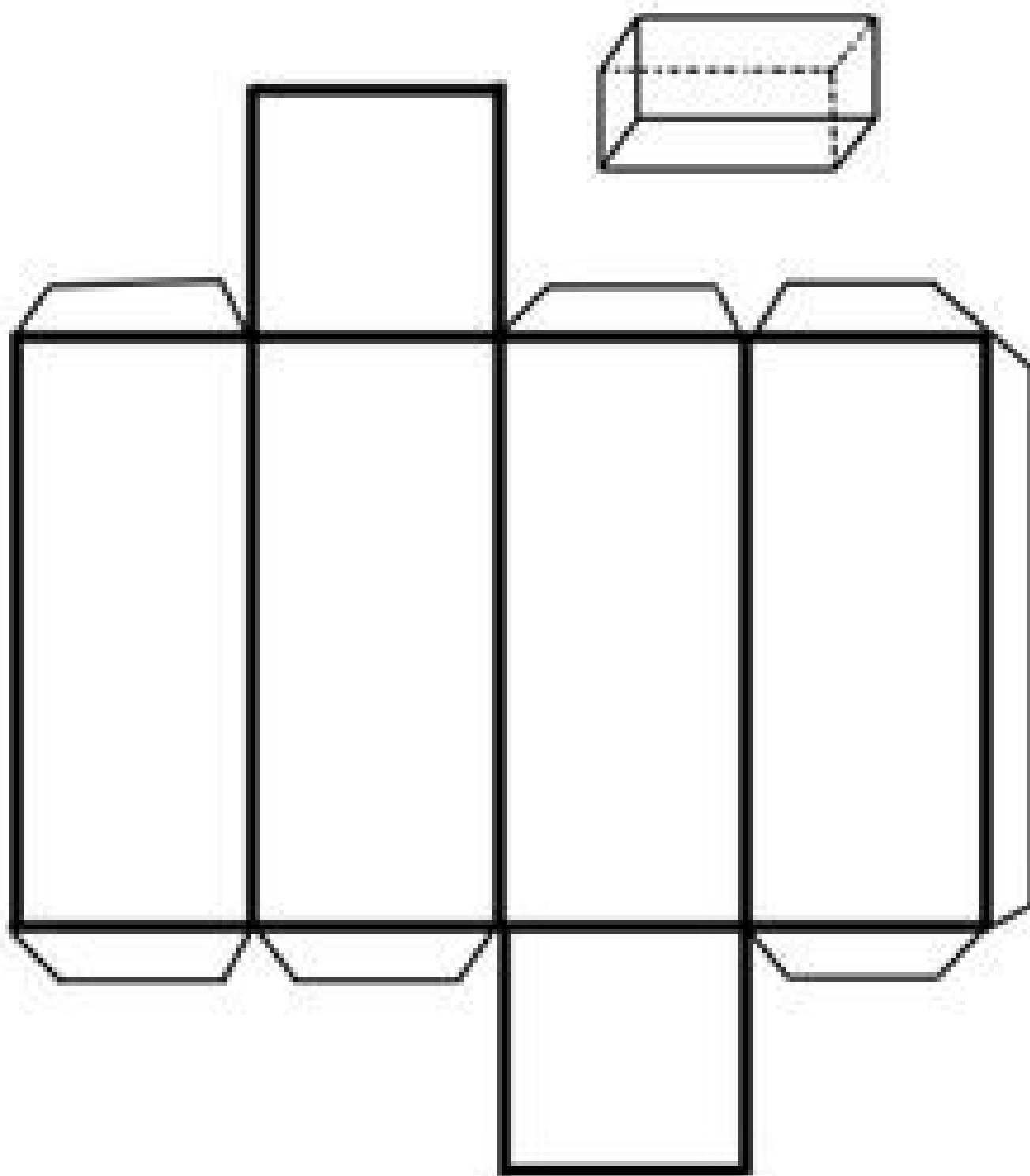

PRISMA RETANGULAR

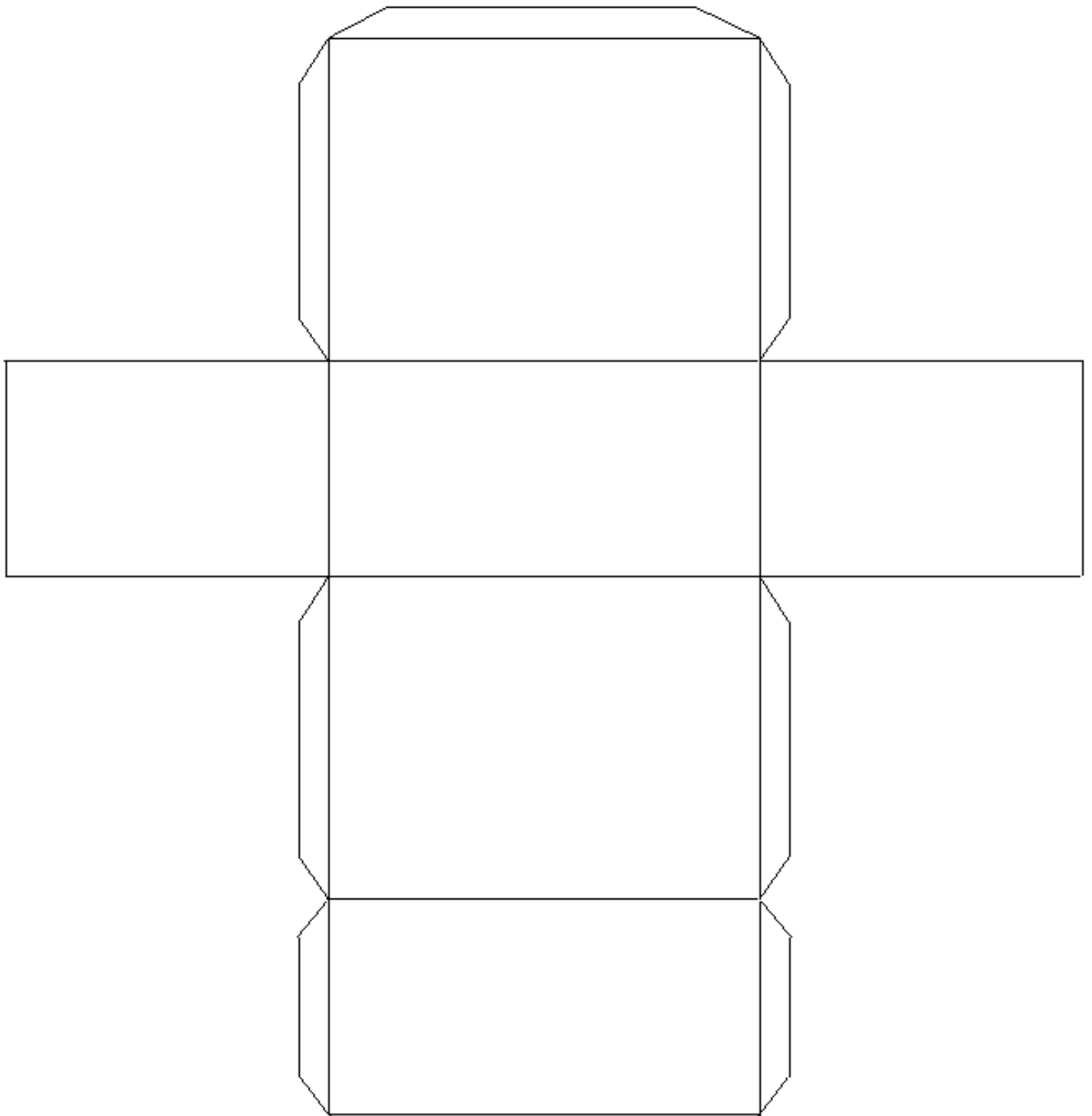

CUBO

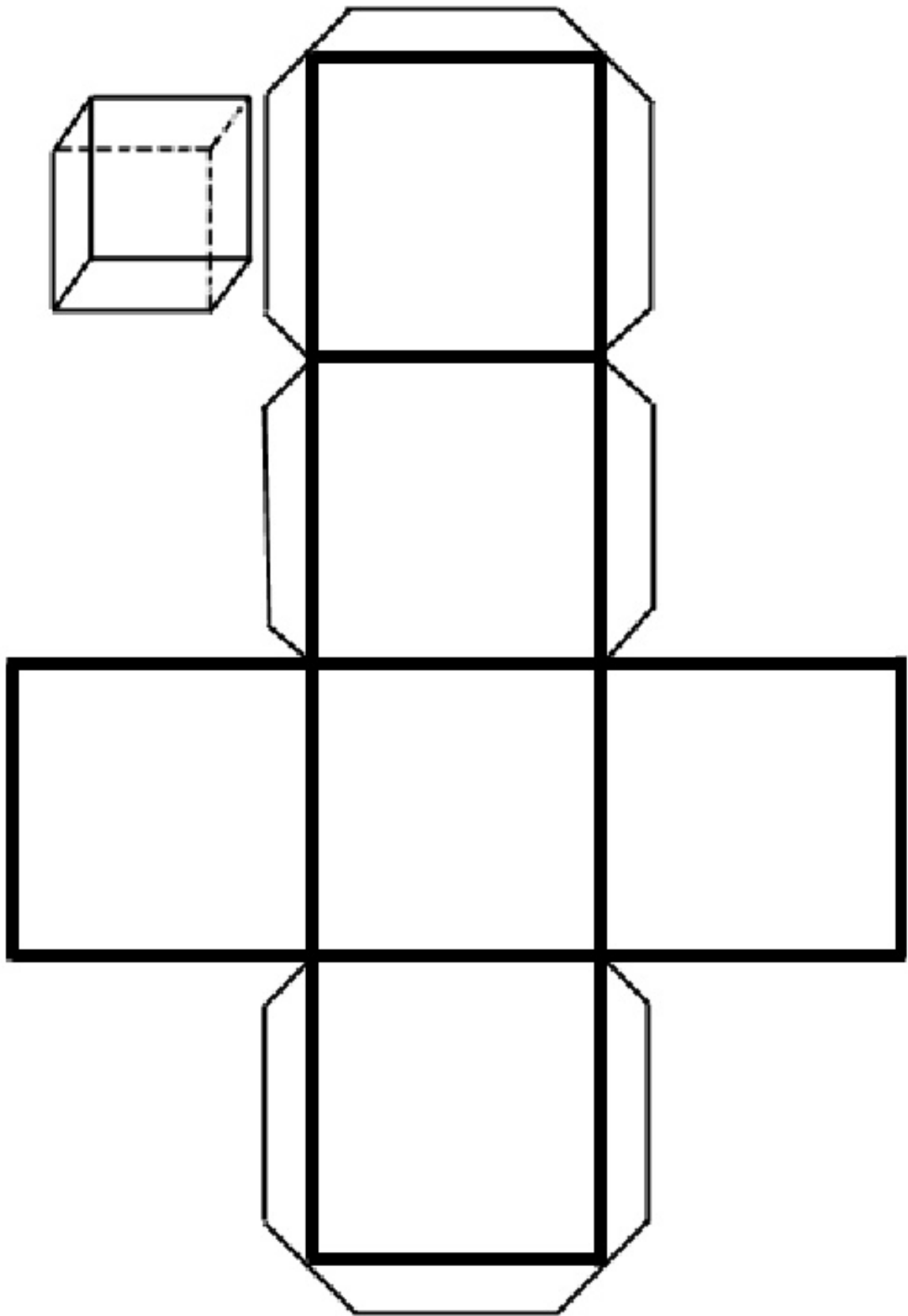

PIRÂMIDE PENTAGONAL

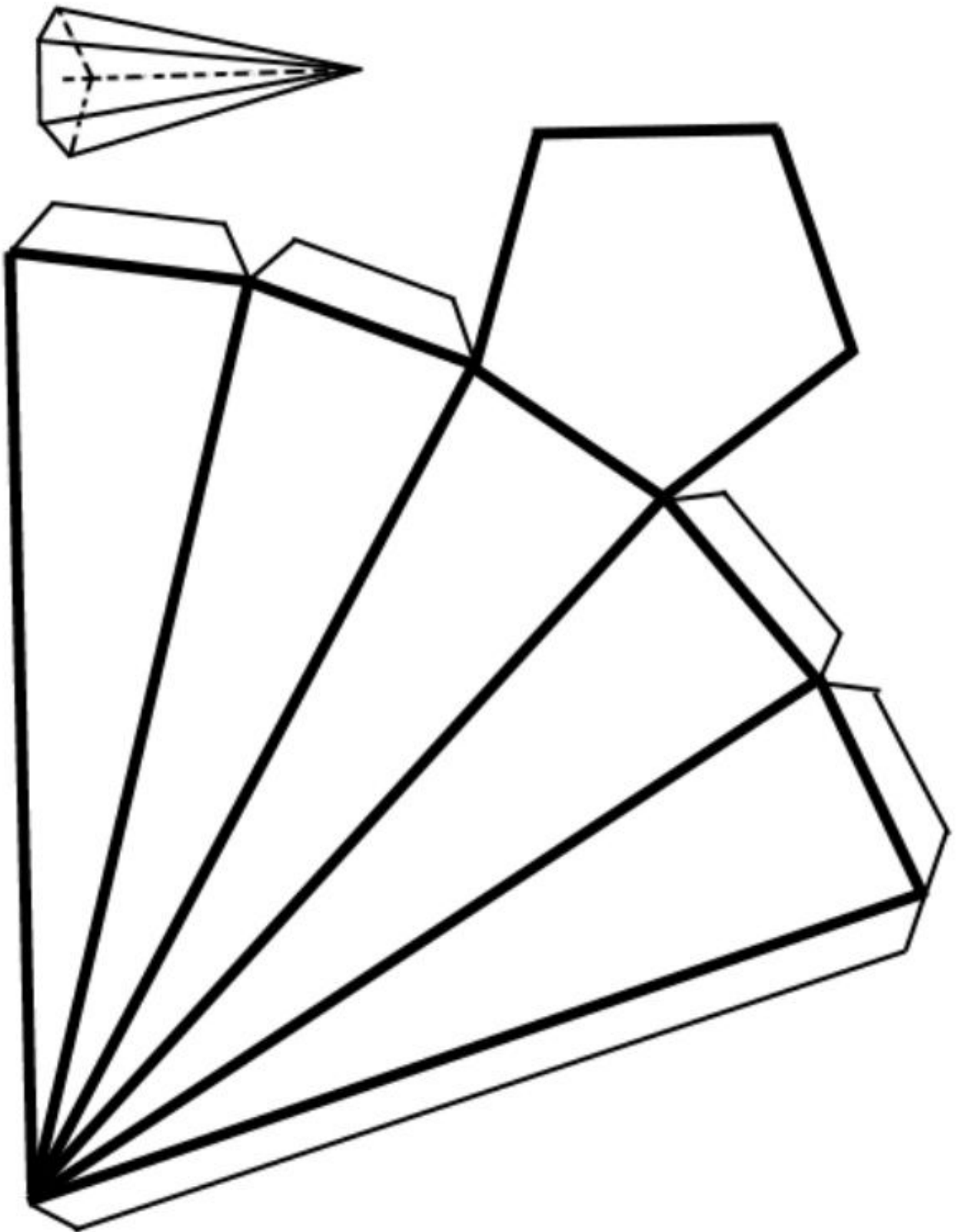

PRISMA PENTAGONAL

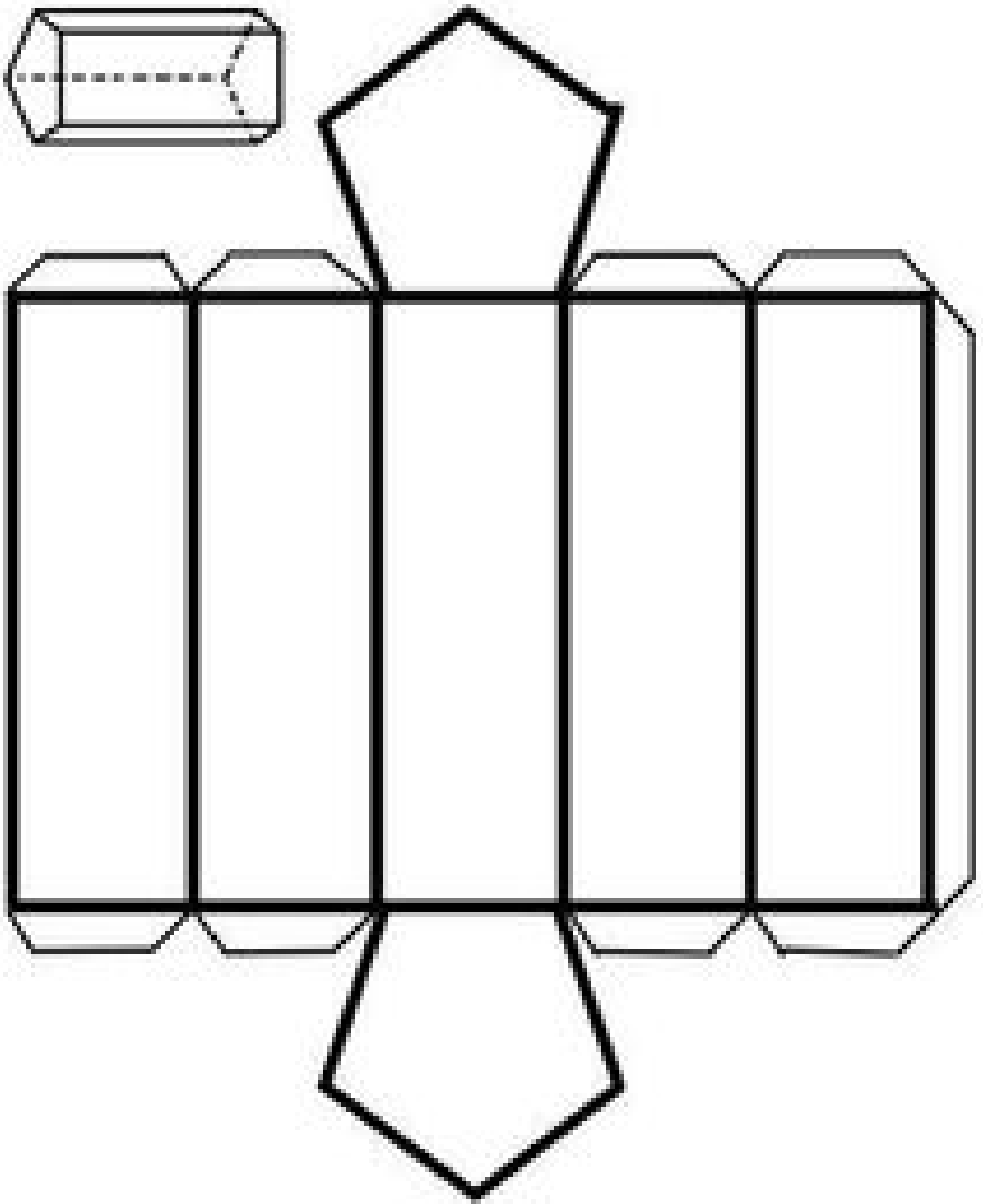
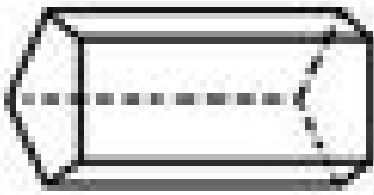

PIRÂMIDE HEXAGONAL

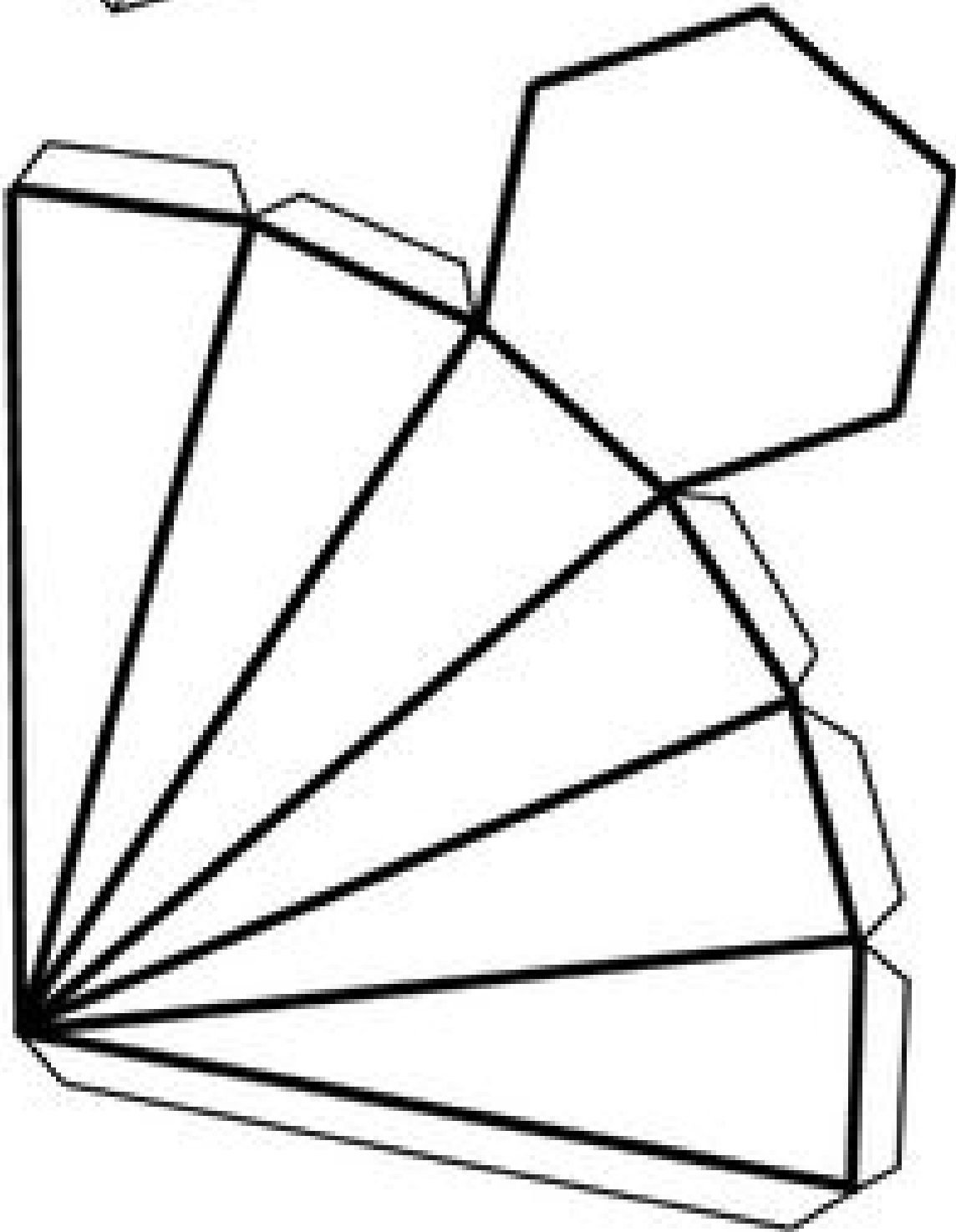
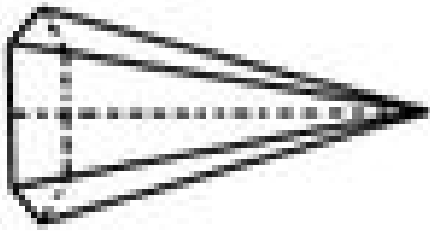

PRISMA HEXAGONAL

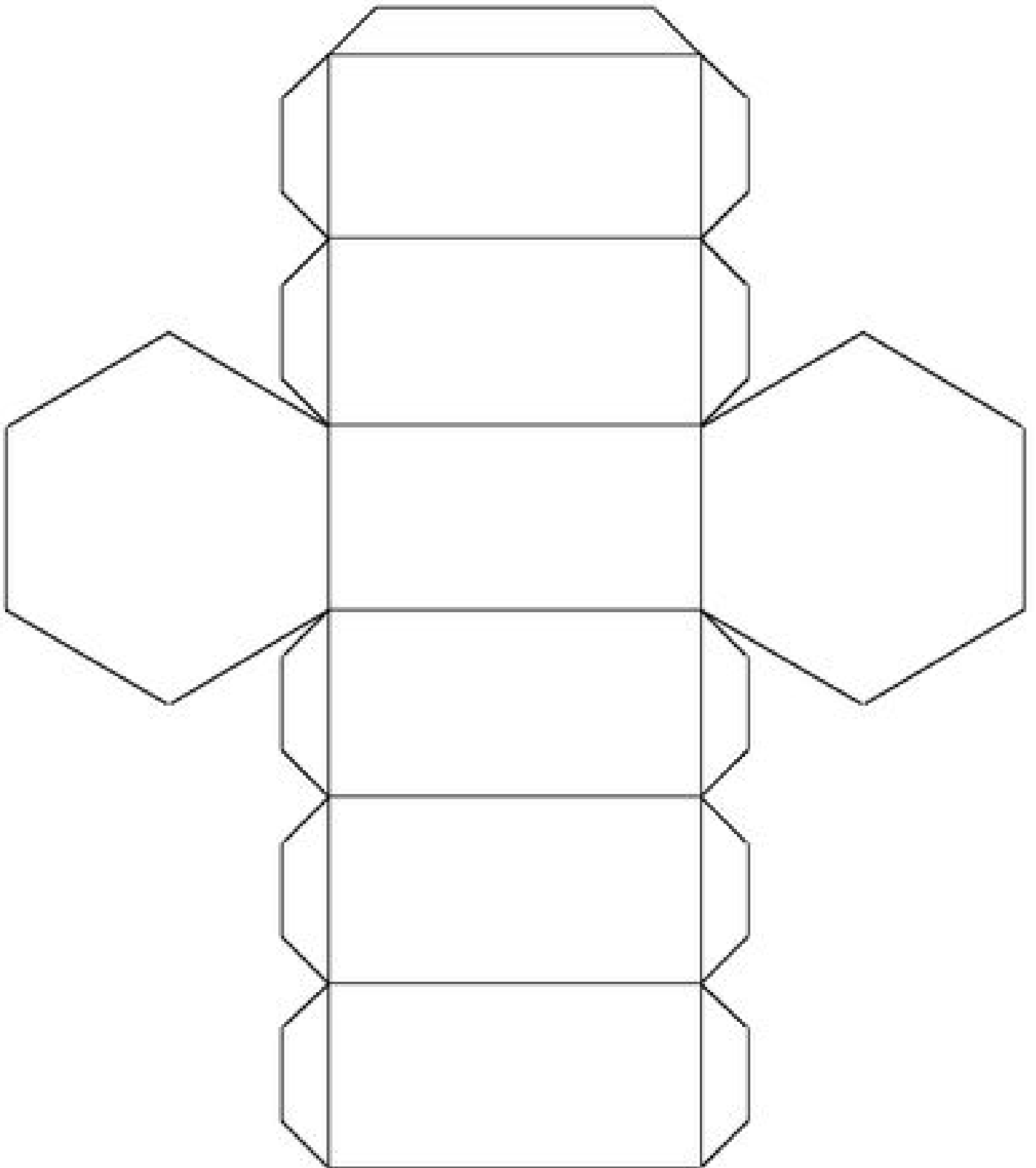

PIRÂMIDE HEPTAGONAL

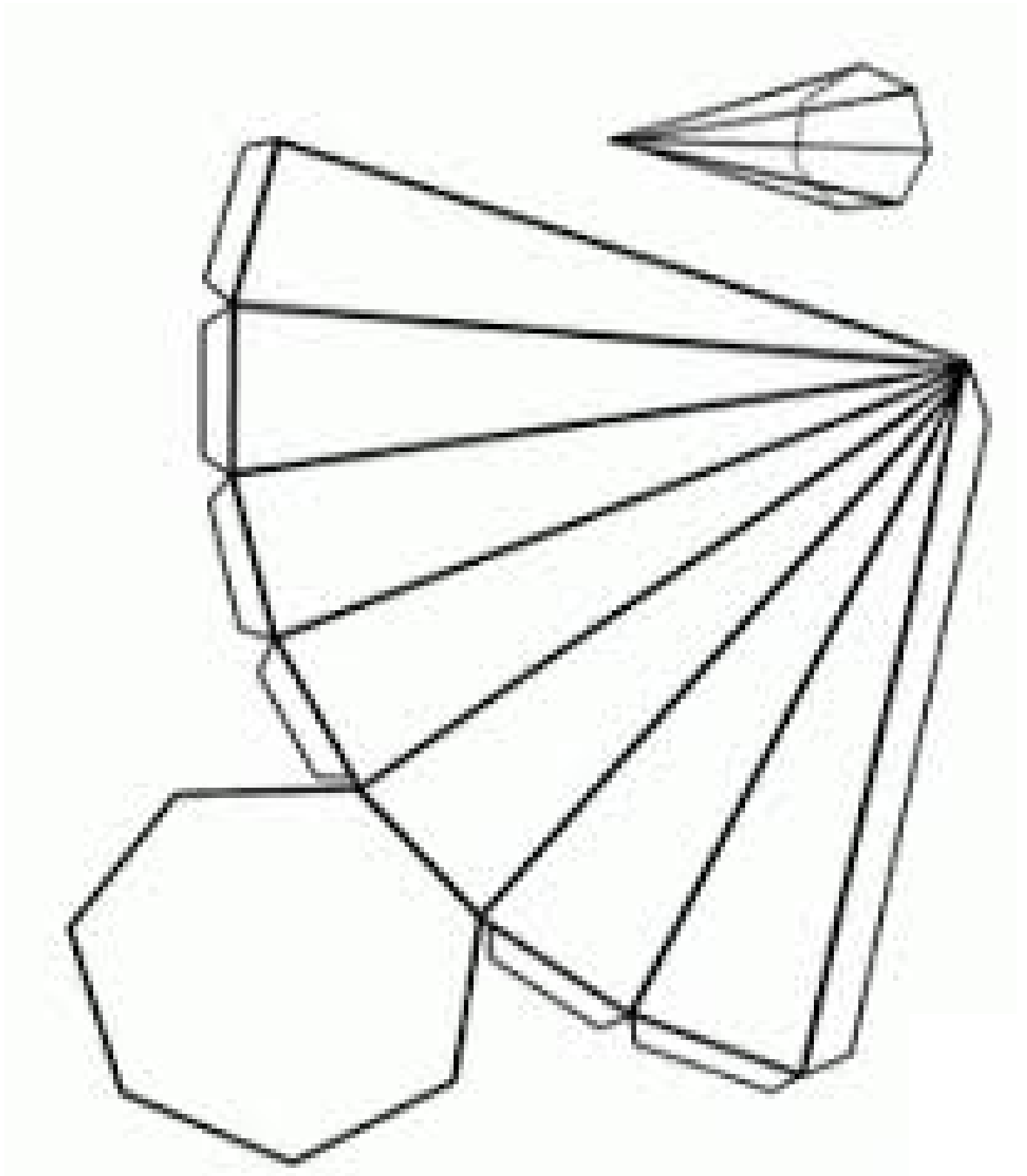

PRISMA HEPTAGONAL

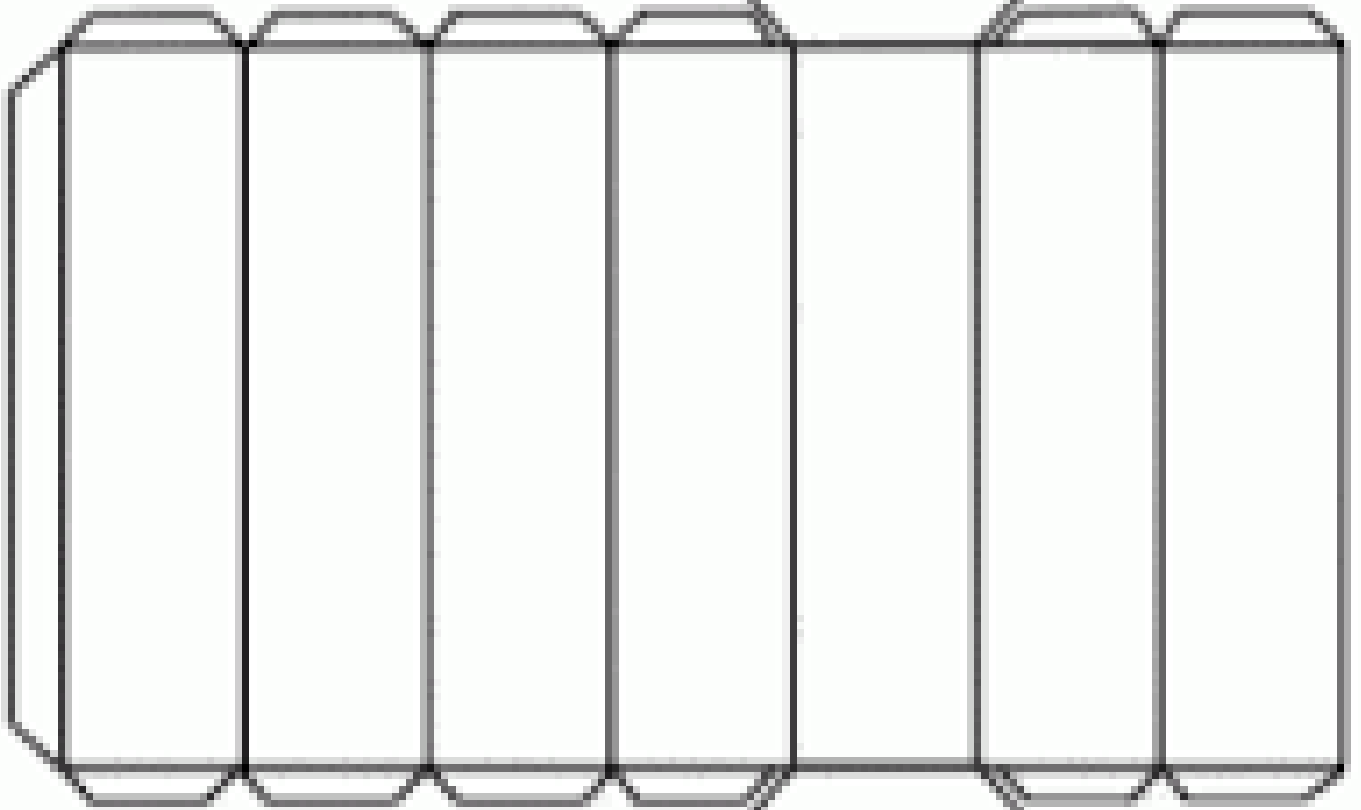
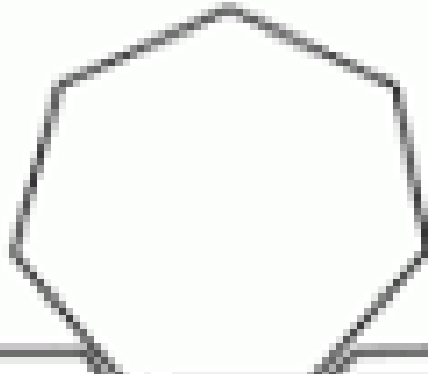
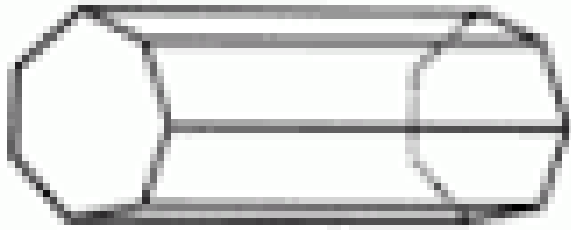

PIRÂMIDE OCTOGONAL

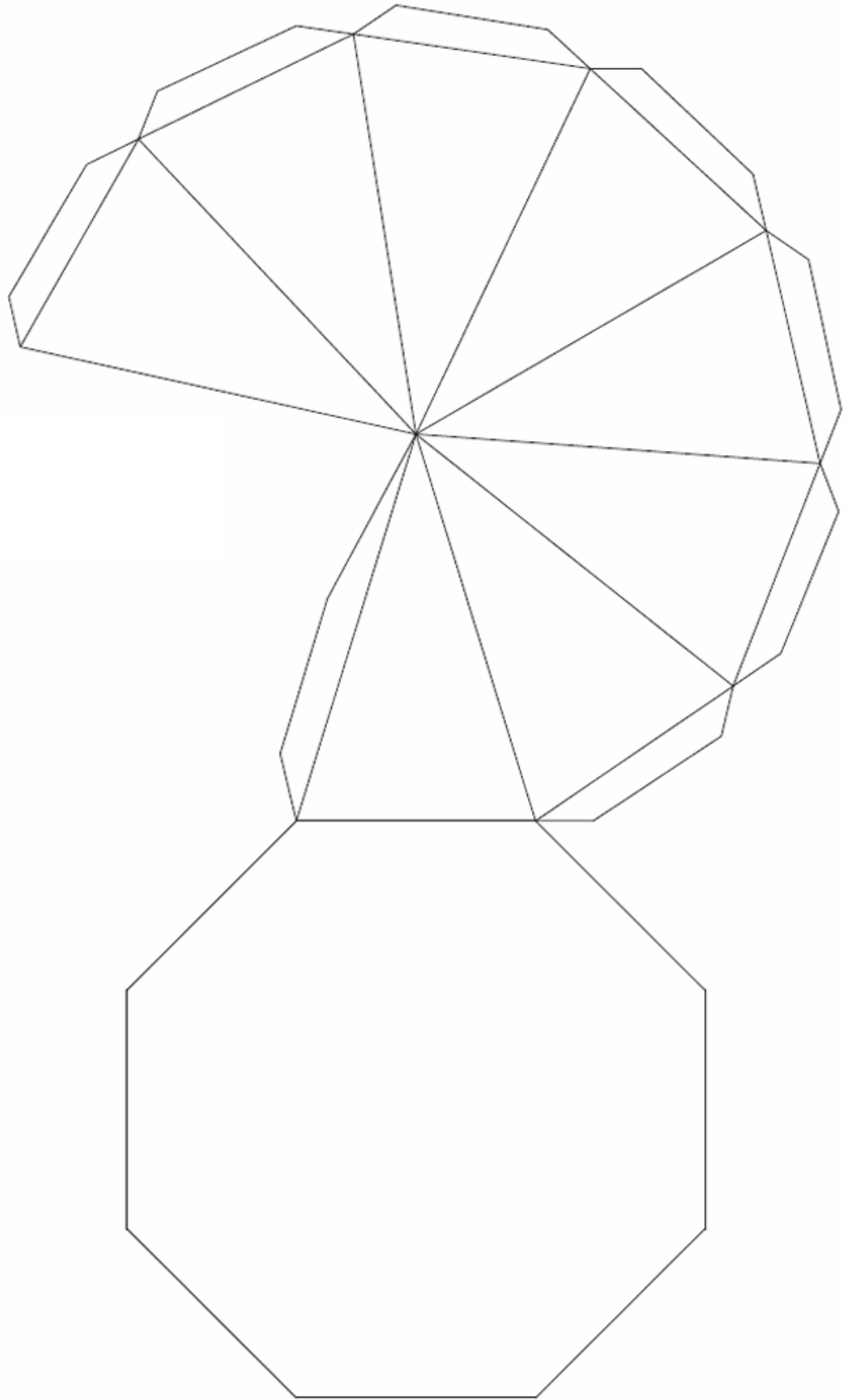

PIRÂMIDE OCTOGONAL

